

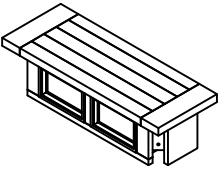

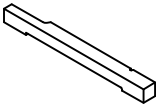

PARTS LIST					
NO.	DESCRIPTION	QTY.	NO.	DESCRIPTION	QTY.
1		1	2		4
	Top				
3		1			
	Shelf				

HARDWARE LIST					
NO.	DESCRIPTION	QTY.	NO.	DESCRIPTION	QTY.
A		12	B		12
				Washer M8	
C		1	D		12
				Spring Washer M8	

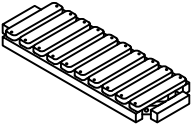

**2**

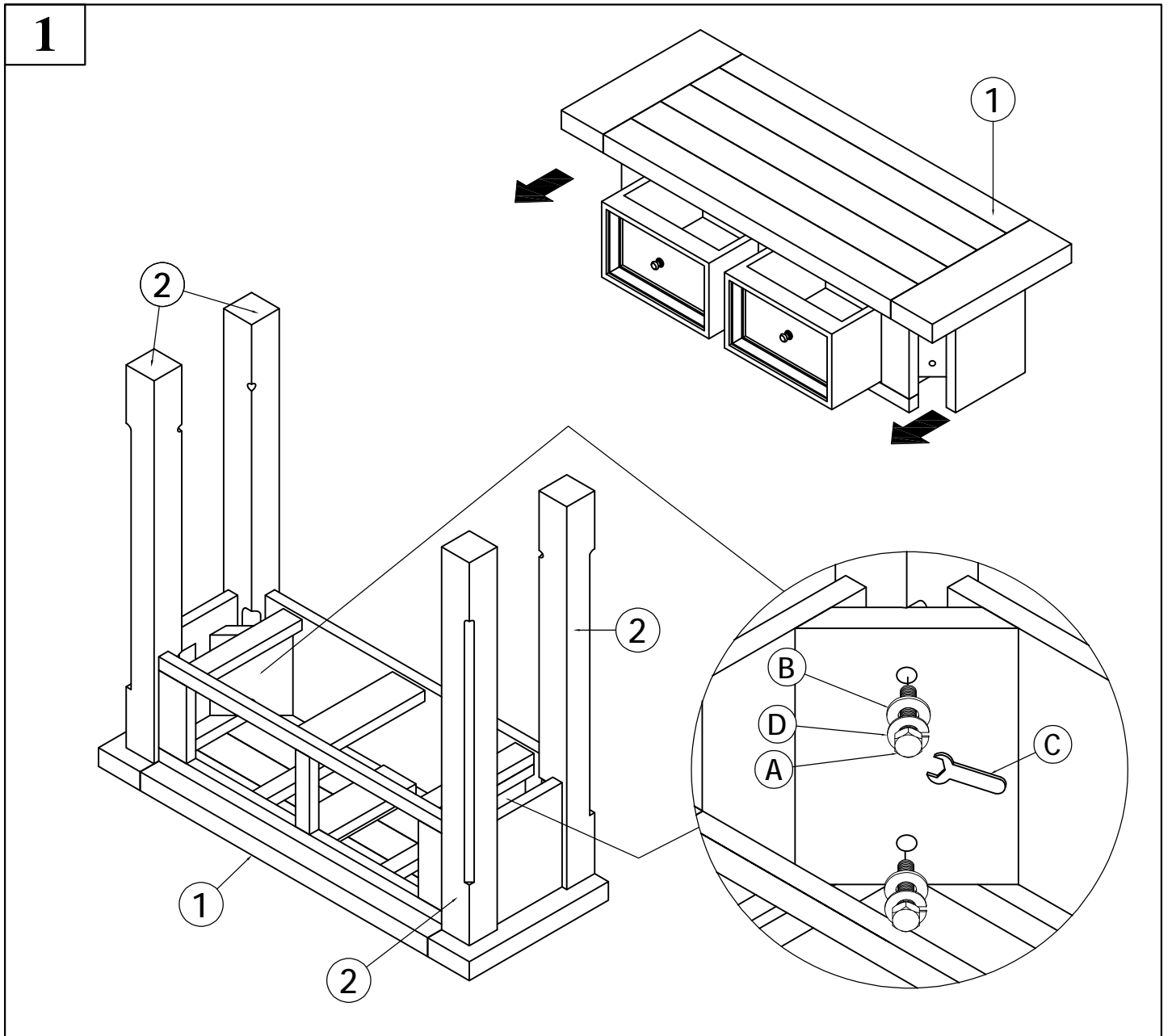