

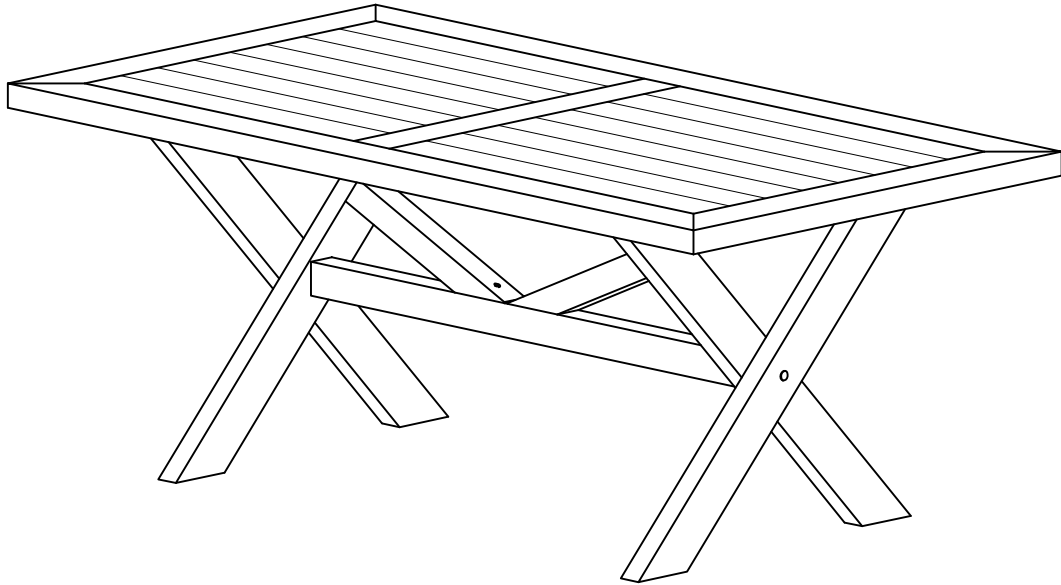









Thank you for purchasing this quality product. Be sure to check all packing material carefully for small parts that may have come loose inside the carton during shipment.

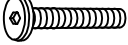

HARDWARE LIST

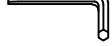
| NO | DESCRIPTION | QTY |
|----|---|-----|
| A |  BOLT M10 x 120 | 2 |
| B |  BOLT M10 x 80 | 4 |
| C |  WASHER M10 | 6 |
| D |  SPRING WASHER M10 | 6 |
| E |  NUT M10 | 6 |
| F |  17mm HEX WRENCH | 1 |
| G |  BOLT M8 x 60 | 4 |
| H |  WASHER M8 | 4 |
| I |  SPRING WASHER M8 | 4 |
| J |  ALLEN KEY M4 | 1 |

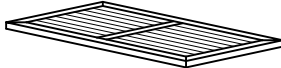
PART LIST

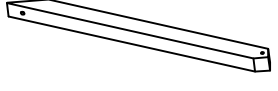
| NO | DESCRIPTION | QTY |
|----|--|-----|
| 1 |  TABLE TOP | 1 |
| 2 |  LEGS | 4 |
| 3 |  CENTER RAIL | 1 |
| 4 |  SUPPORT | 2 |

Thank you for purchasing this quality product. Be sure to check all packing material carefully for small parts that may have come loose inside the carton during shipment.

STEP 1

Assemble part (1) & (2)



A:2



B:4



C:6



D:6



E:6



F:1

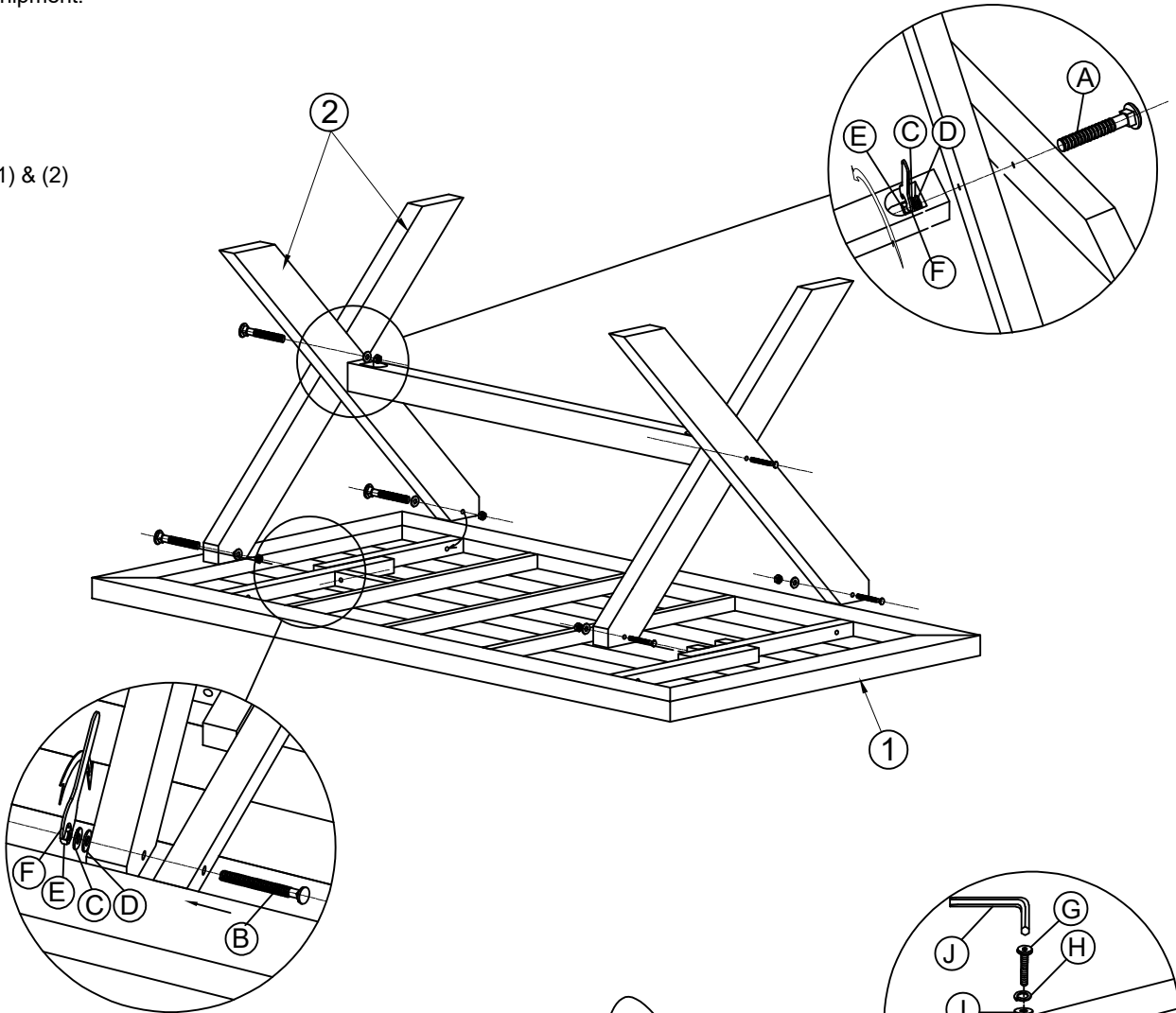

STEP 2

Assemble part (3) & (4)

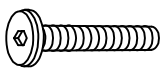

G:4



H:4



I:1



J:1

