

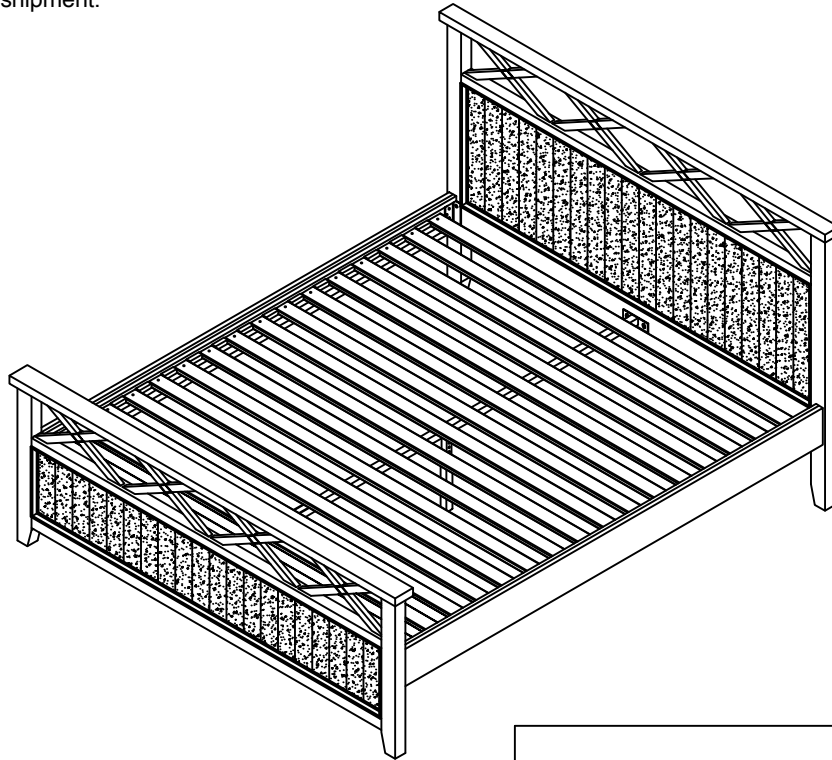







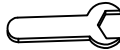
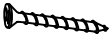

Thank you for purchasing this quality product. Be sure to check all packing material carefully for small parts that may have come loose inside the carton during shipment.

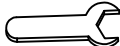

HARDWARE LIST			
NO	DESCRIPTION		QTY
A		BOLT M10 X 30	12
B		WASHER M10	12
C		17mm HEX WRENCH	1
D		SCREW M4 X 30	32
E		BOLT M8-20	1
F		BOLT M8-40	1
G		NUT M8	1
H		13mm HEX WRENCH	1
I		SPRING WASHER	12

PART LIST			
NO	DESCRIPTION		QTY
1		HEADBOARD	1
2		FOOTBOARD	1
3		SIDE RAIL	2
4		CENTER SUPPORT RAIL	1
5		SLAT	16

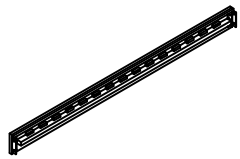
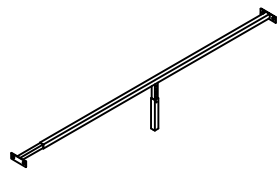
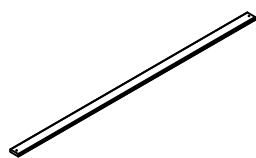
Thank you for purchasing this quality product. Be sure to check all packing material carefully for small parts that may have come loose inside the carton during shipment.

STEP 1

Assemble part (1) & (2), (3)

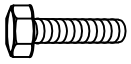

A:8



B:8



C:1



I:8

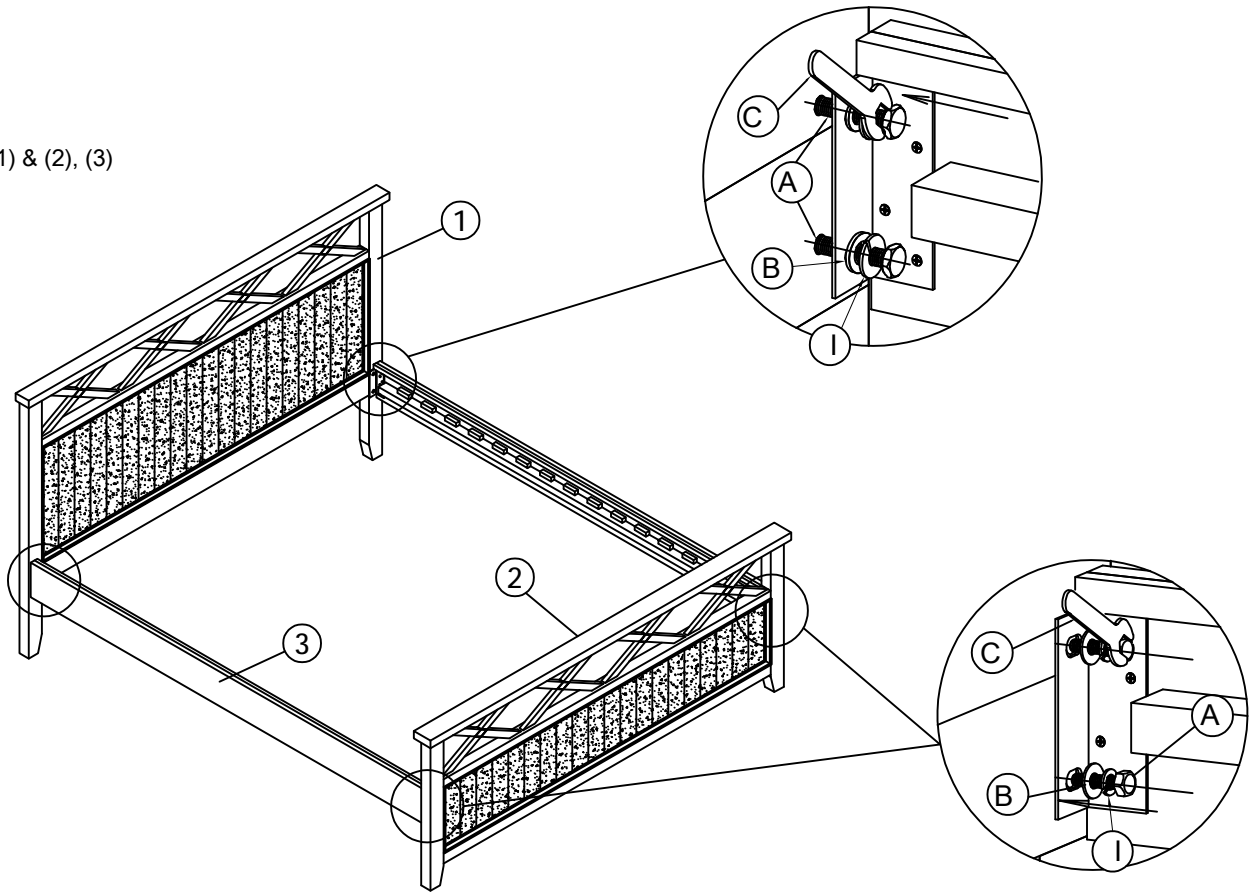

STEP 2

Assemble part (4)



E:1



F:1



G:1



H:1

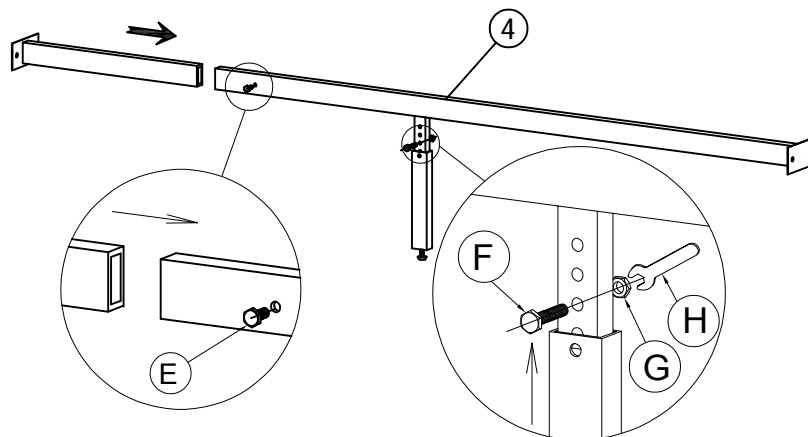

Thank you for purchasing this quality product. Be sure to check all packing material carefully for small parts that may have come loose inside the carton during shipment.

STEP 3

Assemble part (4)

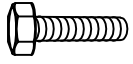

A:4



B:4



I:4

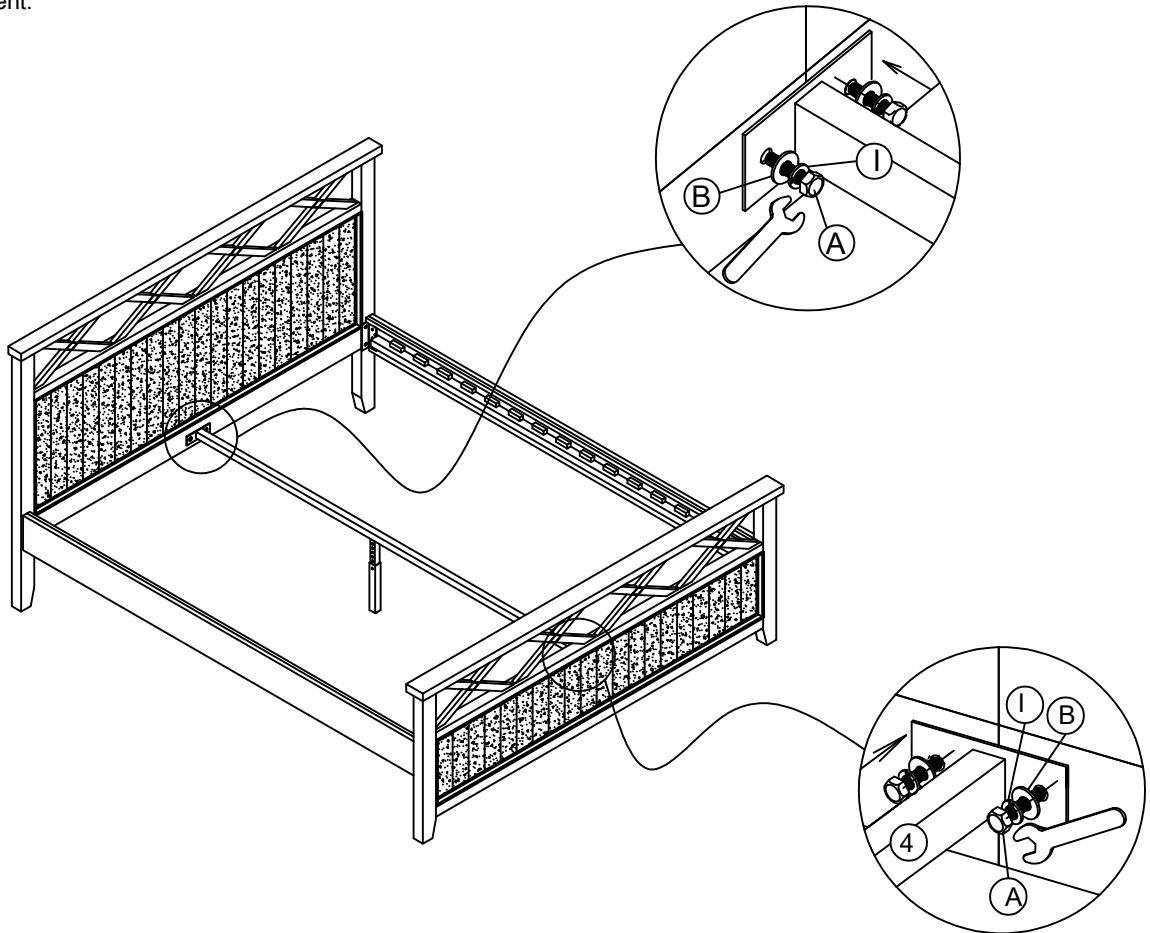

STEP 4

Assemble part (5)

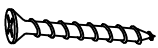

D:32

